



Arbiton
FLOOR EXPERT

FLOOR
COLLECTION

LVT ПОДОВА НАСТИЛКА – КАКВО Е ТОВА?

LVT = LUXURY VINYL TILE

ЛУКСОЗНИ ВИНИЛНИ ПЛОЧКИ

Многослоен модулен под направен от пластмаса,
главно PVC.

MMFA, Multilayer Modular Floor Association

Асоциация на многослойни модулни подове

Капиталовата група DECORA е член на сдружението
още от 2013 г.



Слоеве на ТРАДИЦИОННО LVT –
наричано в тази презентация
ПЪРВА ГЕНЕРАЦИЯ LVT

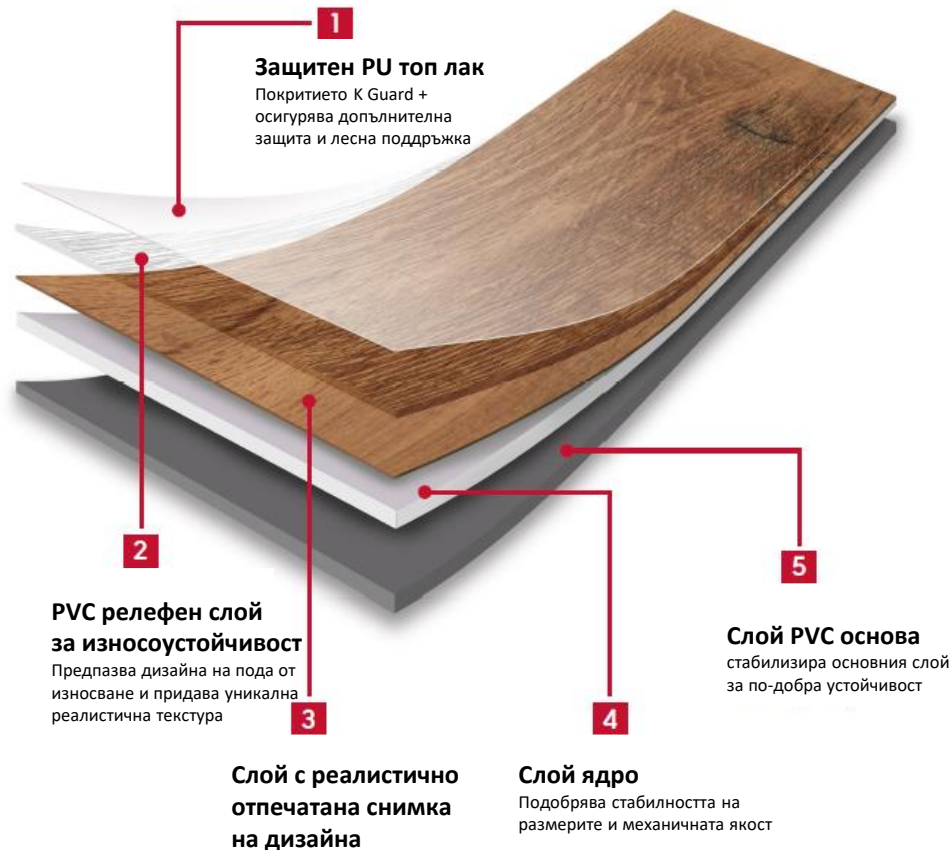

LVT ПОДОВЕ КАТЕГОРИЗАЦИЯ

ИНСТАЛАЦИЯ:

1. Плаваща инсталация–

- LVT Клик - 4,0мм - 10,00мм
- LVT Loose Lay - повече/по-малко от 5.0мм
 - С противоплъзгаща повърхност,
 - Монтиран със специално лепило

2. Инсталация чрез лепене

- LVT суха основа– от 2,0мм до 2,5мм
- LVT самозалепващо се – от 2,0мм до 2,5мм (Gerflor)



ТРАДИЦИОНЕН LVT ПОД (1-ва ГЕНЕРАЦИЯ)

СИЛНИ СТРАНИ

- трайност, устойчив на повреди и дълъг живот;
- топъл под
- по-добра акустика в сравнение с ламината
- устойчив на влага
- малка дебелина, идеален за реновация;
- перфектен за подово отопление
- лесно почистване
- гъвкав, лесен за инсталация
- пожароустойчив (трудногорим)
- устойчив на химикали
- противоплъзгаща повърхност



ТРАДИЦИОНЕН LVT ПОД (1-ва ГЕНЕРАЦИЯ)

НЕДОСТАТЪЦИ:

- деформиране при много високи или много ниски температури (претърпява линейни разширения)
- изисква перфектна повърхност, всички несъвършенства на основата се отразяват на пода
- LVT с HDF ядро не са 100% водоустойчиви
- чуплив клик



ПРЕДИМСТВАТА НА LVT

LVT спрямо ЛАМИНАТ

LVT е:

- Устойчив на надраскване
- Топъл и приятен на допир
- Устойчив на влага
- Тих под
- Антистатичен (малко прах)
- Подходящ за подово отопление

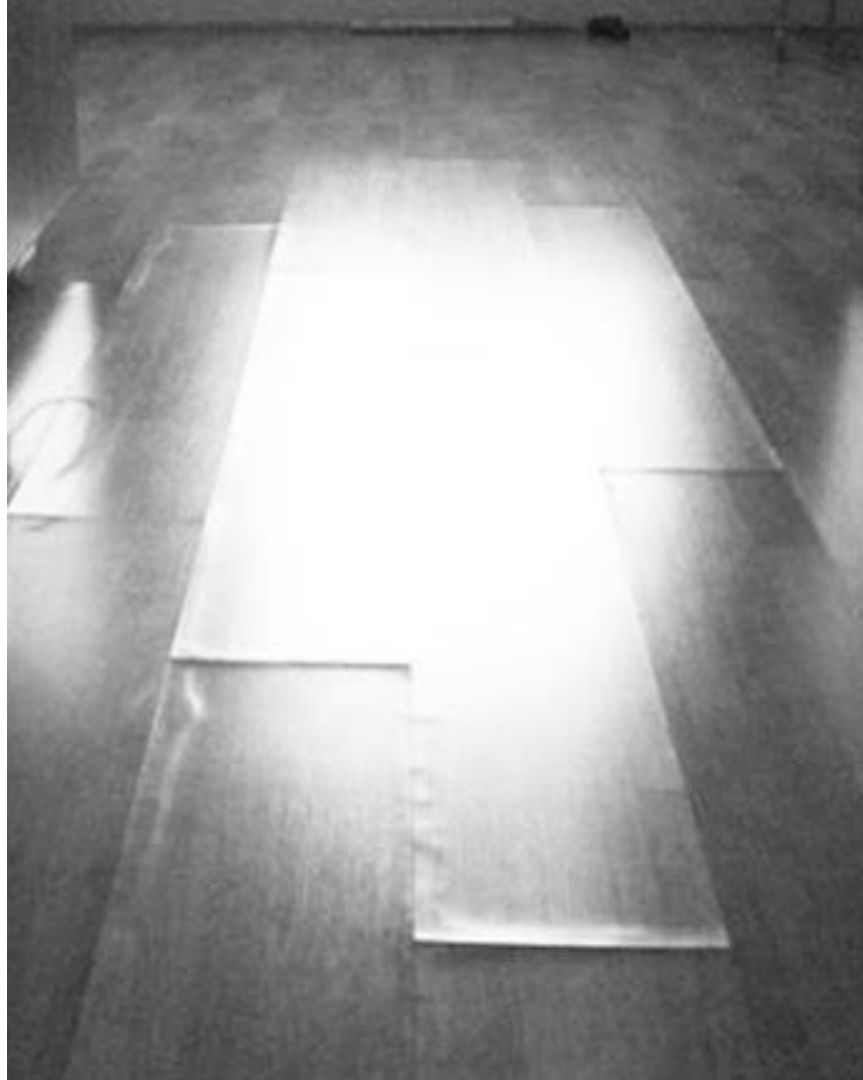

ПРЕДИМСТВАТА НА LVT

LVT спрямо ДЪРВЕН ПАРКЕТ

LVT е:

- Лесен за поддръжка
- Лесен за бърза реновация: лесен за монтаж, без прах, и др.
- Устойчива на удари повърхност
- Устойчив на влага
- Най-добър за подово отопление



ПРЕДИМСТВАТА НА LVT

LVT спрямо КЕРАМИЧНИ ПЛОЧКИ

LVT е:

- Много по-лесен за ремонт на дома: лесен монтаж, без прах и др.
- Без свързване – лесна употреба, без мръсотия
- Топла повърхност



ИНТЕНЗИВНОСТ

КАТЕГОРИИ
ИЗНОСОУСТОЙЧИВОСТ
НА ПОДА

УПОТРЕБА

Жилищна

Слаба



Средна

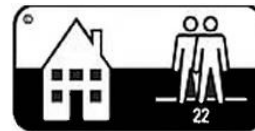

Висока



Търговска

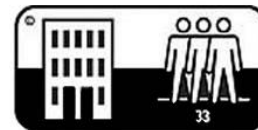
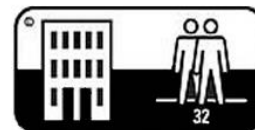

Индустриална

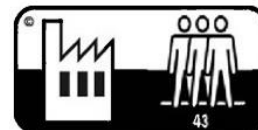
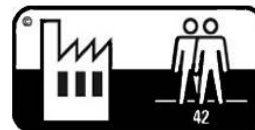
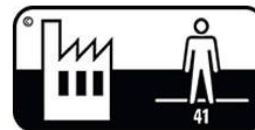

КАТЕГОРИИ ИЗНОСОУСТОЙЧИВОСТ според АС КАТЕГОРИЗАЦИЯ

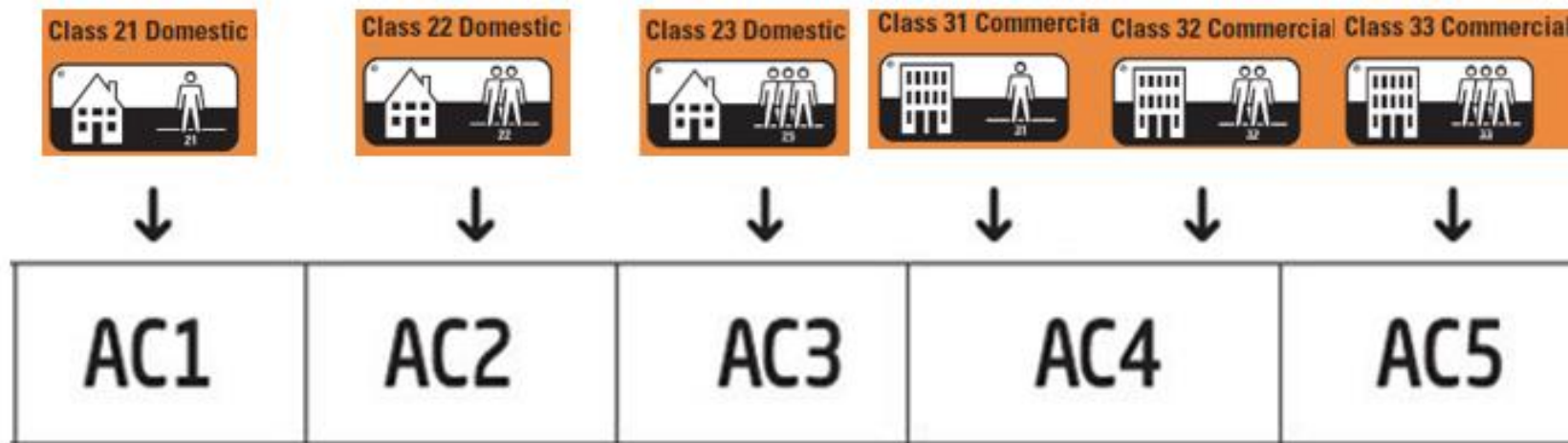

КЛАСОВЕ ИЗНОСОУСТОЙЧИВОСТ

LIBERAL , AMARON, AROQ →

LIBERAL →

AMARON, AROQ →

AMARON, AROQ →

Клас	Натовареност	Употреба
ЖИЛИЩНА		
21	умерена	Зони, използвани много малко или от време на време, напр. спални
22	нормална	Помещения със средна интензивност на движение, дневни
23	голяма	Интензивни условия на използване, напр. входни зали, коридори
ТЪРГОВСКА		
31	умерена	Област с ниска интензивност на движението или използвана от време на време, напр. хотелски стаи, малки офиси или конферентни зали
32	нормална	Зони с интензивност на среден трафик, напр. малки магазини
33	голяма	Зони с висок интензитет на трафика, напр. учебни зали, коридори, магазини, офиси
34	много голяма	Интензивно използвани помещения, напр. входни зали, универсални магазини
ИНДУСТРИАЛНА		
41	умерена	Зони, където работата се извършва в седнало положение, използват се колички с полиуретанови меки колела, напр. чисти климатични помещения
42	нормална	Зони, където работата се извършва в изправено положение, използват се колички с полиуретанови меки колела, напр. работилници, складове
43	голяма	Силно използвани помещения на леката промишленост

КАКВО ПРЕДСТАВЛЯВА ДИЗАЙНА НА LVT ПОДОВАТА НАСТИЛКА

- **ДИЗАЙН**- изображение на дървесна или друга повърхност:
 - Стандартен двуцветен печат с валяк
 - Многоцветен печат с валяк
 - Дигитален печат– модерната технология, за пресъздаване на дизайна
- **СТРУКТУРА НА ПОВЪРХНОСТТА :**
 - Типична структура на LVT със силна и ясна дървена структура
 - Деликатна “мека” структура
 - Синхронизирана структура– EIR = релефна повърхност



КАКВО ПРЕДСТАВЛЯВА ДИЗАЙНА НА LVT ПОДОВАТА НАСТИЛКА

- **ПОВЪРХНОСТ ЛАК / МАТ:**
 - ЛАК
 - ПОЛУ-МАТ
 - МАТ
- **ЗАВЪРШЕК – свързване**
 - МИКРО ФАСКА
 - ФАСКА
 - СИЛНО ИЗРАЗЕНА ФАСКА



КАКВО ПРЕДСТАВЛЯВА ДИЗАЙНА НА LVT ПОДОВАТА НАСТИЛКА

- **ФОРМАТ/РАЗМЕР**

- Стандартна ширина: 18-19см
- Премиум колекция -
Широка "люксовна" дъска: 23см
- Стандартна дължина: 120-125см
- Премиум колекция -
Дълга "люксовна" дъска: 150см



ЗАПОМНЕТЕ!

ТРАДИЦИОННИЯ LVT ПОД (1ва ГЕНЕРАЦИЯ)

- **ДЕФОРМИРА СЕ ПРИ МНОГО ВИСОКА И МНОГО НИСКА ТЕМПЕРАТУРА**
- **ИЗИСКВА ПЕРФЕКТНИ ПОВЪРХНОСТИ**
- **МНОГО ЧУПЛИВ КЛИК**

ОСНОВНИЯТ ПРОБЛЕМ Е МНОГОСЛОЙНОТО ЯДРО



Arbiton
FLOOR EXPERT

FLOOR
COLLECTION

НИЕ ПРЕДЛАГАМЕ

НОВА ГЕНЕРАЦИЯ LVT ПОД

ЕДНО ЯДРО



**INSPIRED
BY NATURE**

В нашите лаборатории открихме
иновативна смес от естествени скални минерали и съвременни полимери,
за да предложим максимално усъвършенстван под.



HD

**HD
MINERAL
CORE**



**HARDNESS AND
DURABILITY OF
NATURAL ROCK
MINERALS**

+



**THE FLEXIBILITY OF
MODERN POLYMERS
BASED ON CARBON
MOLECULES**



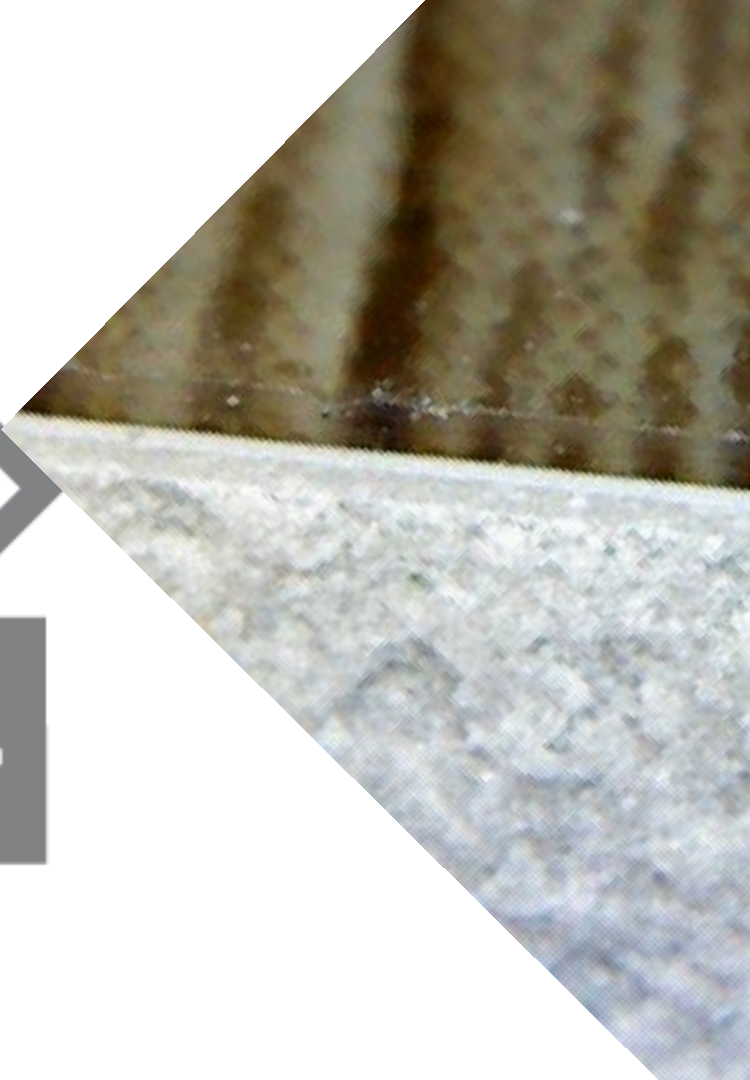

HD

**HD
MINERAL
CORE**



ЗДРАВ КЛИК = УСТОЙЧИВ ПОД

HD минерално ядро= изключително здрава клик система= максимално устойчив под

Нашата клик система е **2 пъти по-здрава** от средните LVT клик, познати на пазара.

УСТОЙЧИВОСТ НА КЛИК СИСТЕМАТА (ISO 24334)

AMARON

Дълга страна 5,2 kN/m
Къса страна 6,5 kN/m

LIBERAL

Дълга страна 5,0 kN/m
Къса страна 6,2 kN/m



ВЕЧЕН ПОД

HD минерално ядро= висока стабилност на размерите дори в много слънчеви помещения

Предлагаме поне **2 пъти по-голяма стабилност на размерите** на нашия под в сравнение с традиционното LVT.

СТАБИЛНОСТ НА ПОДА (EN ISO 23999)
До 0,05%



ЕФЕКТИВНО = ЕВТИНО

Много ниско термично съпротивление = по-ефективно използване на подово отопление

По-високата цена на подовата настилка може да бъде върната след няколко години.

ТЕРМИЧНА УСТОЙЧИВОСТ (EN 12664)
До 0,033 m²K/W



АНАЛИЗ НА ИНВЕСТИЦИЯТА



	HD МИНЕРАЛНО ЯДРО + подложка Multiprotec LVT	ЛАМИНАТ + xps термо	ЛАМИНАТ + подложка Multiprotec 1000
температура на стаята	22 C	22 C	22 C
подова система TR	0,041 m2K/W	0,13 m2K/W	0,086 m2K/W
инвестиция за под + подложка / за 20 кв.м	лв 1466,00	лв 562,00	лв 747,00
Вие плащате по-малко за под (годишно)	лв -	лв 904,00	лв 719,00
годишни разходи за подово отопление / за 20 кв.м	лв 103,00	лв 344,00	лв 229,00
Вие плащате повече за отопление (годишно)	лв -	лв 241,00	лв 126,00

ВЪЗВРЪЩАНЕ НА ИНВЕСТИЦИЯТА СЛЕД 3,8 ОТОПЛИТЕЛНИ СЕЗОНА

(за най-добрата подложка след 6 сезона)



WATER
PROOF



ВОДОУСТОЙЧИВ И УСТОЙЧИВ НА ПЕТНА

Свържете кухненския под с хола и останалите жилищни помещения.

БЕЗ РИСК за Вашия под!

(честото почистване или разлетите напитки не са опасни за вашия под)

100% ВОДОУСТОЙЧИВ

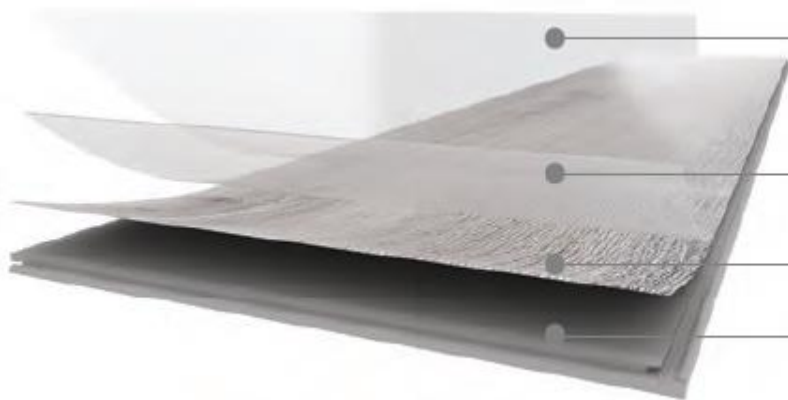

ДВОЕН UV ЗАЩИТЕН СЛОЙ

ИЗНОСОУСТОЙЧИВ СЛОЙ

СЛОЙ НА ДИЗАЙНА

HD МИНЕРАЛНО ЯДРО



ЕДНО ПОМЕЩЕНИЕ, ЕДИН ПОД
дневна – хол - кухня



KITCHEN



LIVING ROOM

HALL

ЕДНО ПОМЕЩЕНИЕ, ЕДИН ПОД
дневна – хол - кухня



KITCHEN
ВОДОУСТОЙЧИВ



LIVING ROOM

ДИЗАЙН
СТАБИЛНОСТ НА РАЗМЕРИТЕ
ПОДОВО ОТОПЛЕНИЕ



HALL

УСТОЙЧИВ
ЗДРАВ КЛИК

НЕКА ОБОБЩИМ!

1 НОВА ГЕНЕРАЦИЯ
LVT ПОДОВА НАСТИЛКА
С НОВО ЯДРО

2 ПРЕДИМСТВА НА
HD МИНЕРАЛНОТО
ЯДРО



**STRONG
LOCKS**



**EXTRA
DIMENSIONAL
STABILITY**



**FLOOR
HEATING**



**WATER
PROOF**



**SILENT
FLOOR**



3

ЛЕСЕН ЗА МОНТАЖ
БЛАГОДАРЕНИЕ НА
ПАТЕНТОВАНА
КЛИК СИСТЕМА



4

МОДЕРЕН ДИЗАЙН,
СЪОБРАЗЕН
С НАЙ-НОВИТЕ
ТЕНДЕНЦИИ

**ONE
SPACE
ONE
FLOOR**

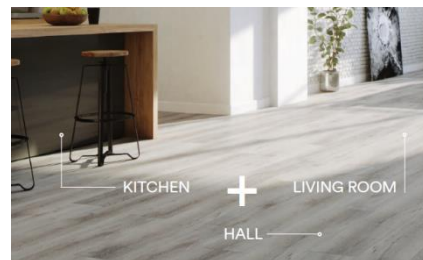



LIBERAL

COLLECTION



229 mm SIZE

1220 mm x 229 mm

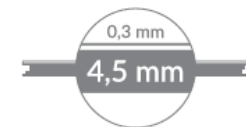



229 mm SIZE

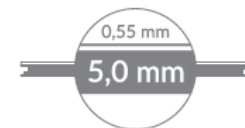
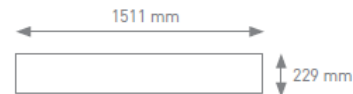

AMARON
COLLECTION



ВИДОВЕ КЛИК СИСТЕМИ, ПРЕДЛАГАНИ НА ПАЗАРА

2G LOCK наричана още ЪГЪЛ - ЪГЪЛ

Метод на инсталация:

Първо се монтира под ъгъл късата страна на панела,
след това се поставя под ъгъл дългата страна.



Down to 3 mm with 2G



ВИДОВЕ КЛИК СИСТЕМИ, ПРЕДЛАГАНИ НА ПАЗАРА

FOLD DOWN locks

Метод на инсталация:

Дългият панел се поставя под ъгъл,
след това късият панел се притиска
надолу.

IVC AND MODULEO
GERFLOR
WINEO
WICKANDERS



1



2



ВИДОВЕ КЛИК СИСТЕМИ, ПРЕДЛАГАНИ НА ПАЗАРА

LOCK 5G – подобрената версия на FOLD DOWN locks

Метод на инсталация:

Дългият панел се поставя под ъгъл,
след това късият панел пада надолу.

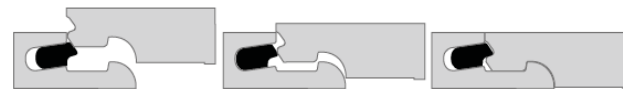

Down to 4 mm with 5G fold down





ВИДОВЕ КЛИК СИСТЕМИ, ПРЕДЛАГАНИ НА ПАЗАРА

UNICLIC® - Basic Locking

2G еквивалент,

Метод на инсталация:

Първо се монтира под ъгъл късата страна на панела, след това се поставя под ъгъл дългата страна.

Angle-Angle



Fold-down technologies

5G еквивалент

Метод на инсталация:

Дългият панел се поставя под ъгъл, след това късият панел пада надолу.



Инсталация – КЛИК

А. Преди инсталация

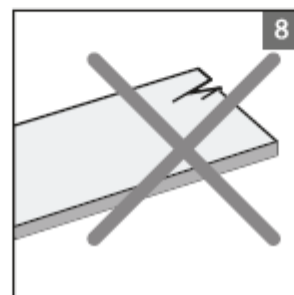
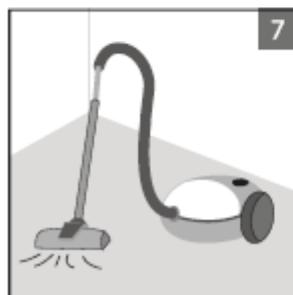
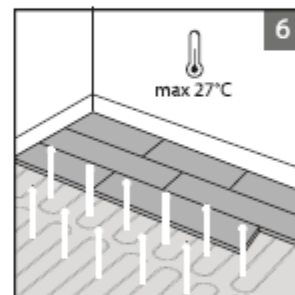
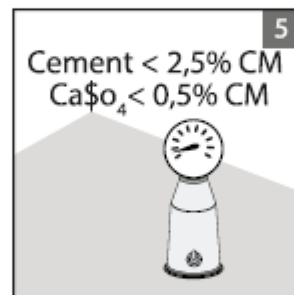
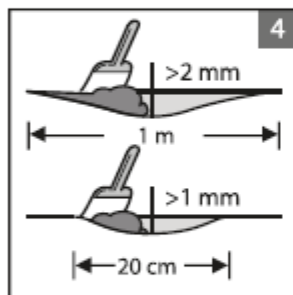
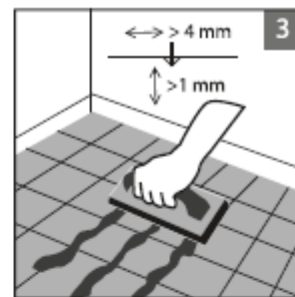
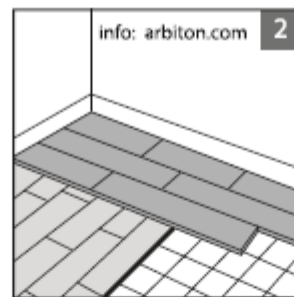
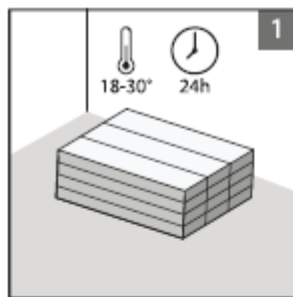

Инсталация – КЛИК

В. Инсталация 2G

Дилатация:

- Стандартна дилатационна (разширителна) фуга– 5мм
- Максимална дължина в една посока 20м, ако е повече фугата се увеличава на 10мм
- Максималната площ без допълнителна дилатационна фуга е 200м²- ако е повече фугата се увеличава до 10мм от стената

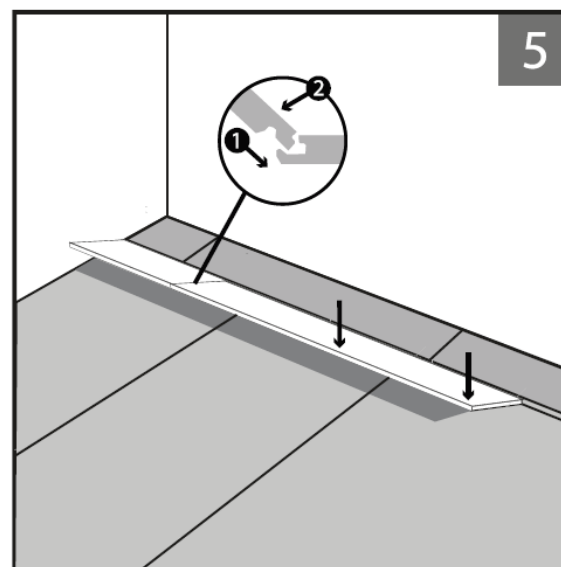
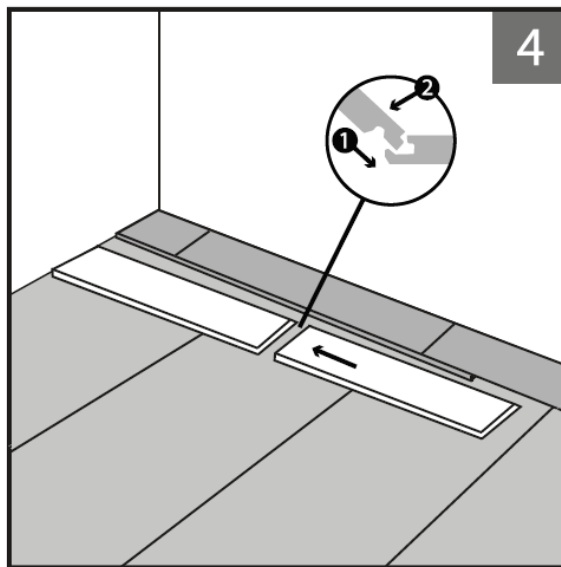
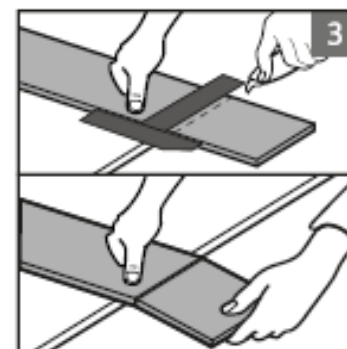
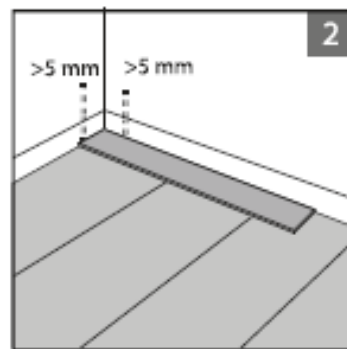
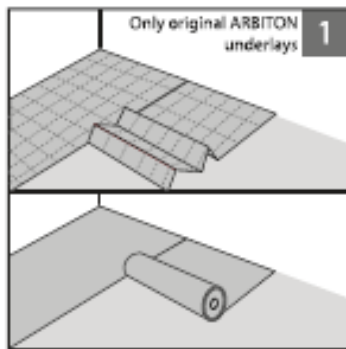

Инсталация – КЛИК

В. Инсталация 5G

Дилатация:

- Стандартна дилатационна фуга– 5мм
- Максимална дължина в една посока 20м, ако е повече фугата се увеличава на 10мм
- Максималната площ без допълнителна дилатационна фуга е 200м²- ако е повече фугата се увеличава до 10мм от стената

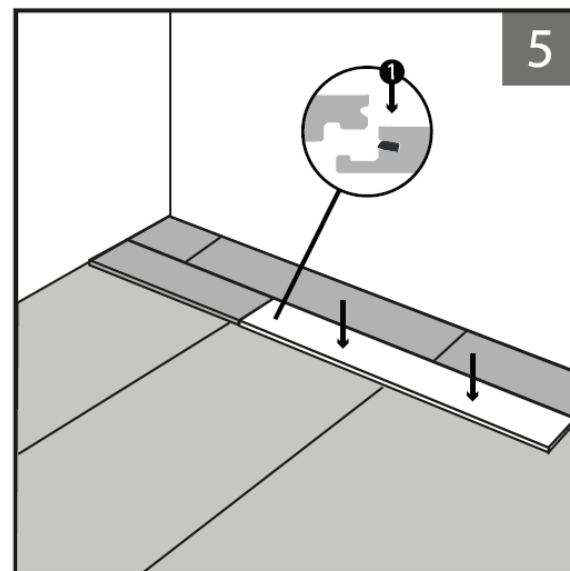
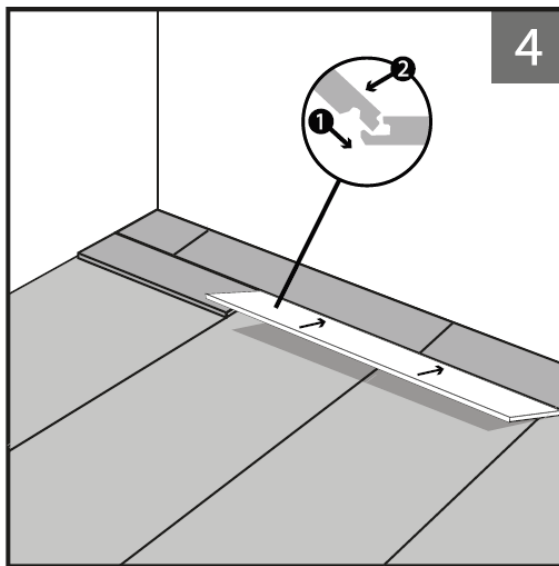
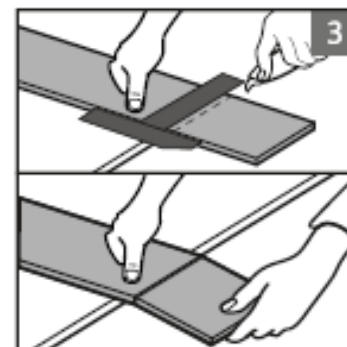
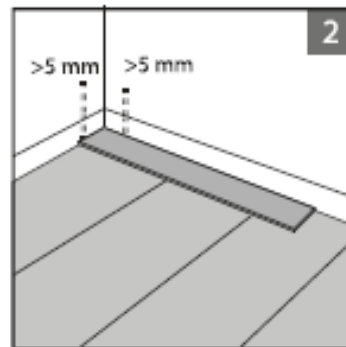
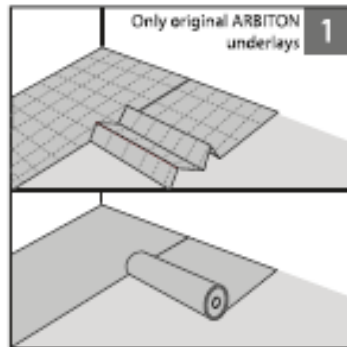

Инсталация – КЛИК

В. Завършване и поддръжка

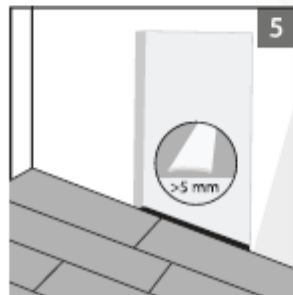
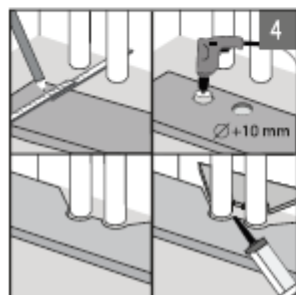
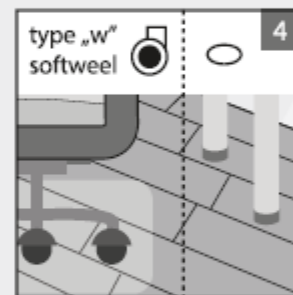
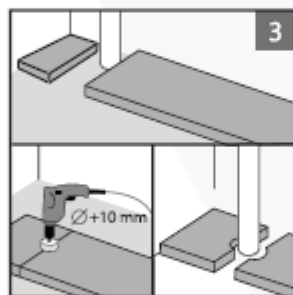
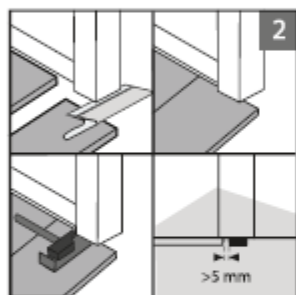
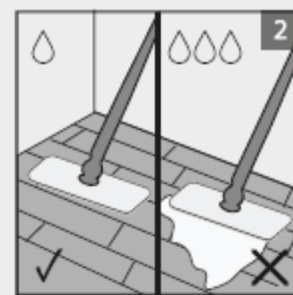
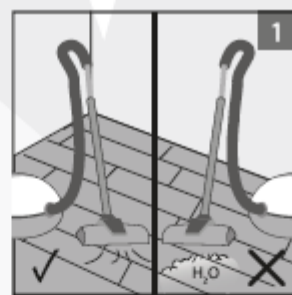
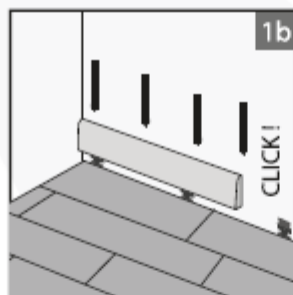
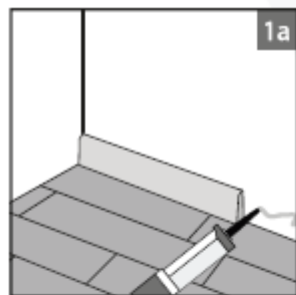



AROQ

COLLECTION

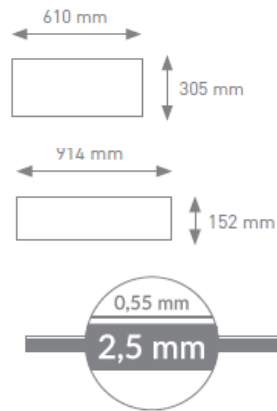

Инсталация – DRY BACK

A. Преди инсталация

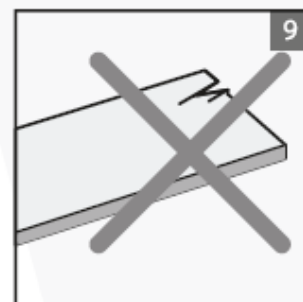
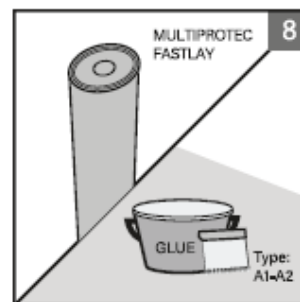
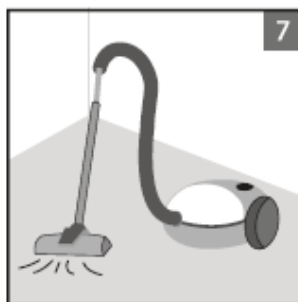
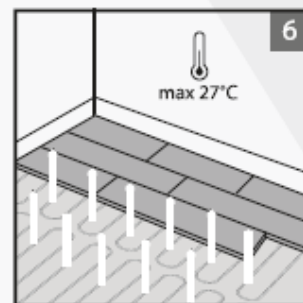
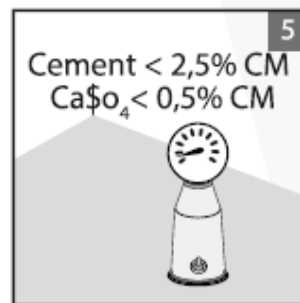
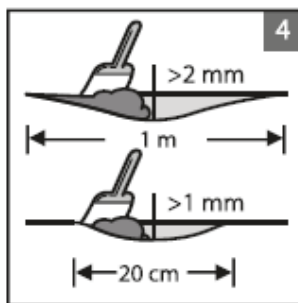
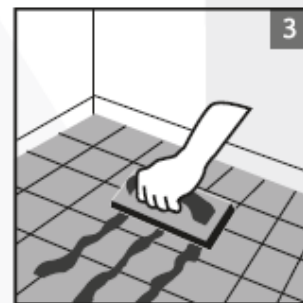
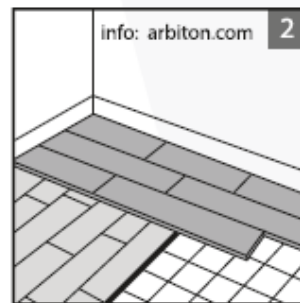
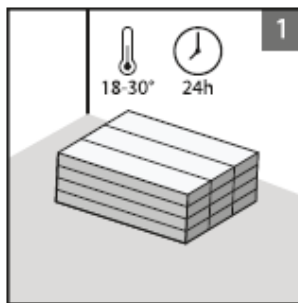

Инсталация – DRY BACK

В. Инсталация

Дилатация FASTLAY:

- Стандартна дилатационна фуга – 2,5мм
- Максимална дължина в една посока 10м, ако е повече фугата се увеличава на 5мм
- Максималната площ без допълнителна дилатационна фуга е 100м²- ако е повече фугата се увеличава до 5мм от стената

Дилатация GLUE:

- Стандартна дилатационна фуга – 2,5мм
- Максимална дължина в една посока 20м, ако е повече фугата се увеличава на 5мм
- Максималната площ без допълнителна дилатационна фуга е 200м²- ако е повече фугата се увеличава до 5мм от стената

GLUE - ЗАЛЕПВАНЕ

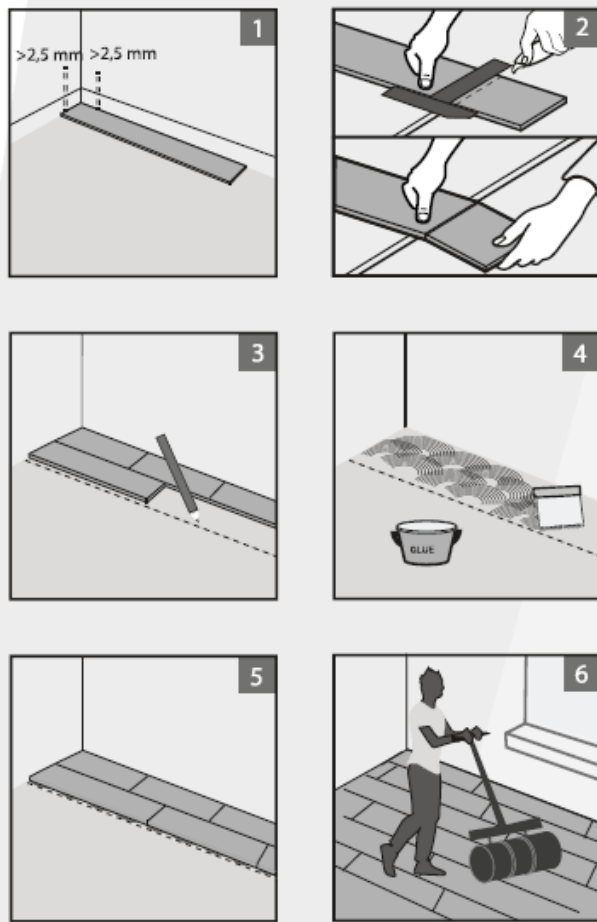

FASTLAY – БЪРЗО ПОЛАГАНЕ

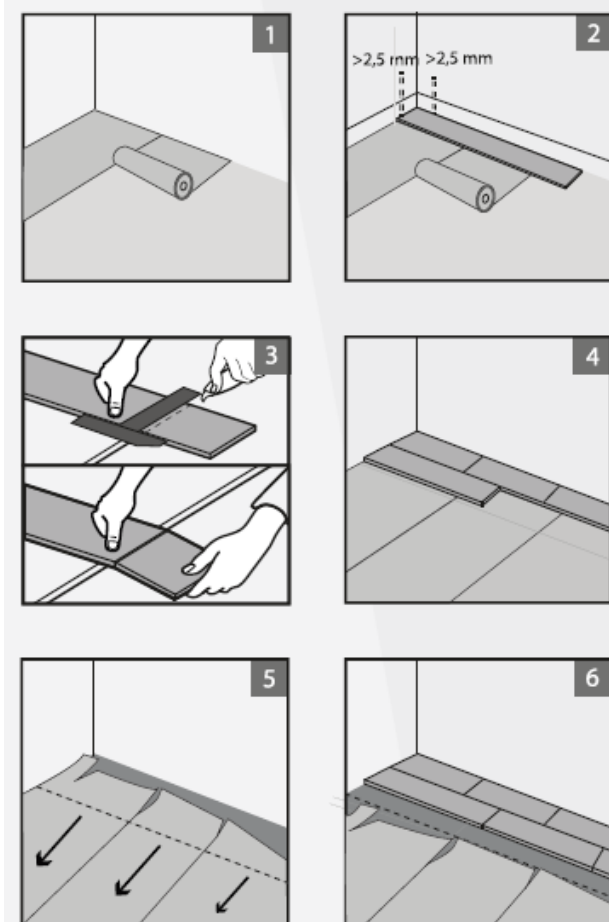

Инсталация – DRY BACK

В. Завършване и поддръжка

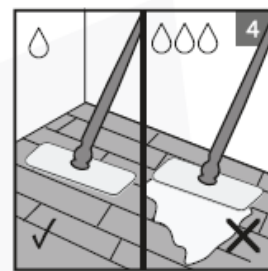
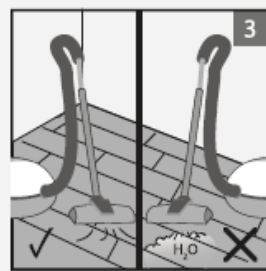
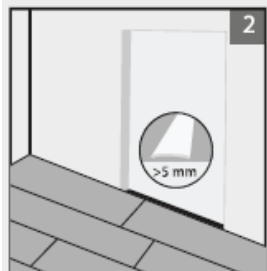
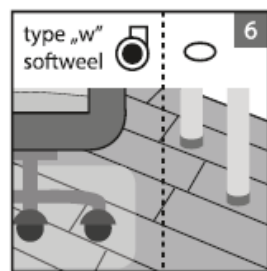
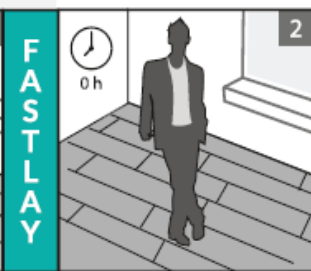
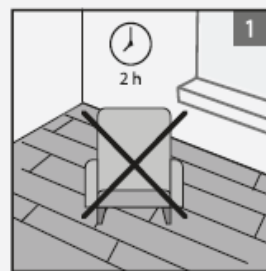
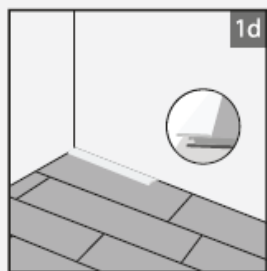
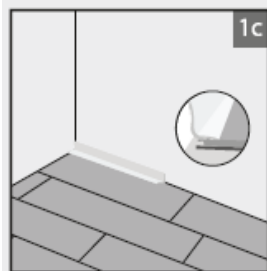
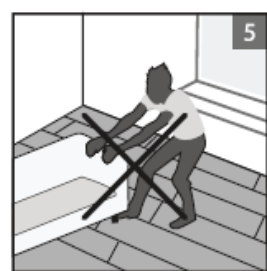
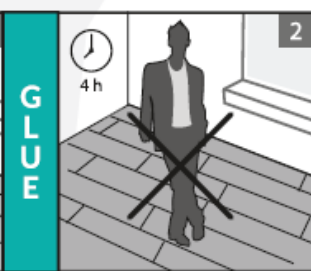
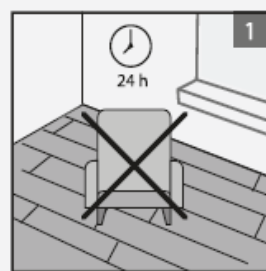
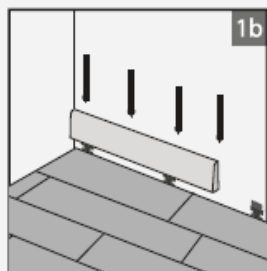
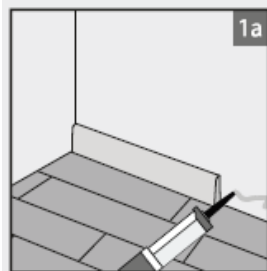

30 продукта

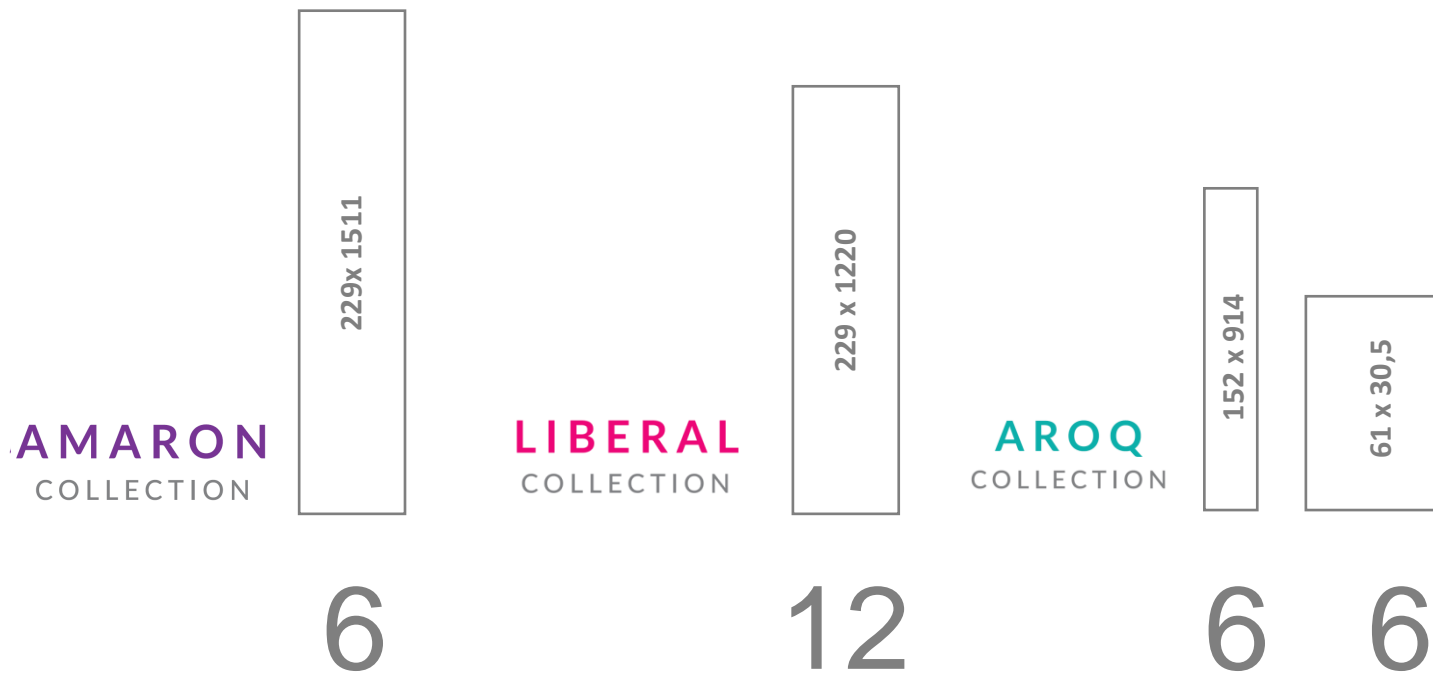

AMARON

COLLECTION



CA 102 ДЪБ АЛЯСКА



CA 117 ДЪБ ЛАХТИ



CA 113 ДЪБ ПАНАМА



CA 114 ДЪБ УИЛЯМСБЪРГ



CA 115 ДЪБ ОРЕГОН



CA 116 ДЪБ АРГОС

LIBERAL
COLLECTION



CL 101 ДЪБ САПОРО



CL 102 ДЪБ АЛЯСКА



CL 103 ДЪБ БЕРГЕН



CL 104 ДЪБ КАНАДСКИ



CL 105 ДЪБ КОНИ



CL 112 ДЪБ БОЛОНЯ



CL 106 ДЪБ ПОРТЛАНД



CL 107 ДЪБ ПАСАДЕНА



CL 108 ДЪБ ДАКОТА



CL 109 ДЪБ ДЖОРДЖИЯ



CL 110 ДЪБ ЯКИМА



CL 111 ОРЕХ НЕВАДА



DA 103 ДЪБ БЕРГЕН

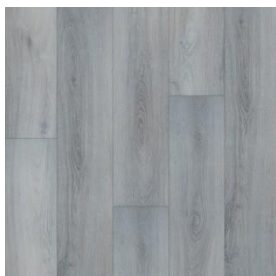

DA 112 ДЪБ БОЛОНЯ



DA 107 ДЪБ БОЛОНЯ



DA 114 ДЪБ УИЛЯМСБЪРГ



DA 111 ОРЕХ НЕВАДА

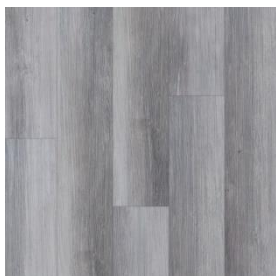

DA 124 ДЪБ КАМДЪН



DA 118 БЕТОН СОХО

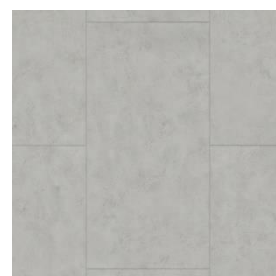

DA 119 БЕТОН ТОРОНТО



DA 120 БЕТОН МАЯМИ



DA 121 БЕТОН БРУКЛИН



DA 122 БЕТОН БРОДУЕЙ



DA 123 БЕТОН МАНХАТЪН

ЕКСПОЗИЦИЯ



← Одно помещение, един под комуникация

← Аксесоари и каталози

← 15 рафта – 2 по дизайна

120 x 80 cm (~ 1 павет)



ПОД - ПОДЛОЖКА - ПЕРВАЗИ - ПРОФИЛИ



ARBITON ПОДЛОЖКИ ЗА LVT



VINCLIC STANDARD MULTIPROTEC LVT



Material: PU/minerals + fleece | Density: 1000 kg/m³ | Reaction to fire: Bfl - s1

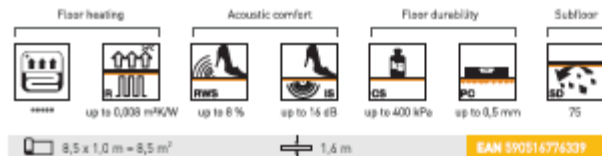

VINLAY RAPID MULTIPROTEC FASTLAY



Material: PU/minerals + fleece | Density: 1400 kg/m³ | Reaction to fire: Bfl - s1

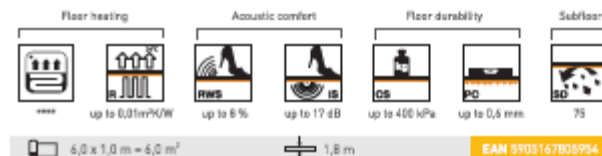

VINCLIC CLASSIC SMART N SECURA LVT CLICK SMART N



Material: Modified XPS/PET | Density: 100 kg/m³

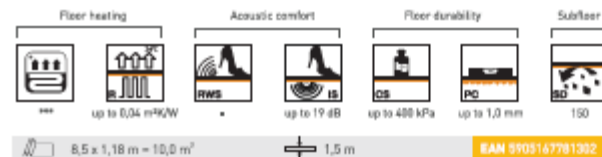

ARBITON ПОДОВИ ПЕРВАЗИ



ONE 60









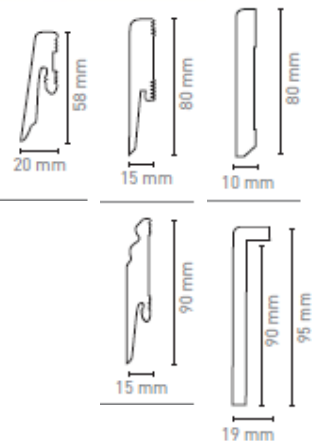





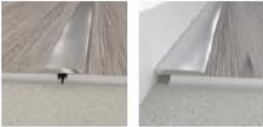





ONE 80



D-ONE

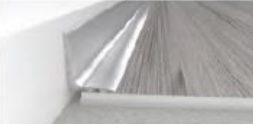

ARBITON ПОДОВИ ЛАЙСНИ

NAME	DESTINATION	WIDTH	MONTAGE	
PRO 20		 20 mm	 BLUE FIX	
PRO DUO 22		 22 mm	 DUO FIX	
PRO 26		 26 mm	 BLUE FIX	
PRO DUO 38		 38 mm	 DUO FIX	
PRO L		 20 mm	 BLUE FIX	

ГАРАНЦИЯ

Жилищно приложение:

LIBERAL – 15 години

AMARON – 20 години

AROQ – 20 години

Обществено приложение:

LIBERAL – 5 години

AMARON – 7 години

AROQ – 7 години

Основни условия:

- Гаранцията покрива: несъответствие на техническите параметри на подовите настилки, с декларираните данни в техническата карта, както и скрити производствени дефекти.
- Първи собственик (гаранцията не покрива вторичен монтаж).
- За обществени помещения гаранцията е валидна при изпълнение в система с Arbiton PU/ Минерални подложки, напр. Multiprotect for LVT
- Гаранцията е валидна при подготвена основа спрямо техническата карта на продукта.
- Гаранцията е пропорционална- стойността на продукта намалява постепенно, пропорционално на времето на използване

Благодарим Ви!