

VOX

Indoor 2014

EN / DE / FR / ES / PL



Colour range • Farbtöne • Couleurs • Gama de colores • Kolorystyka

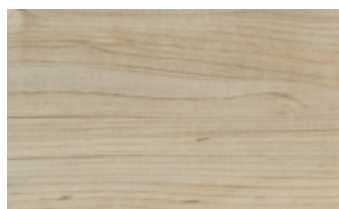

504 maple
504 ahorn
504 érable
504 arce
504 klon

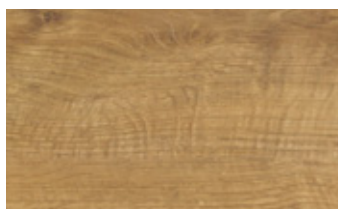

508 dark oak
508 eiche dunkel
508 chêne foncé
508 roble oscuro
508 dąb ciemny



518 andante oak
518 andante-eiche
518 chêne andante
518 roble andante
518 dąb andante

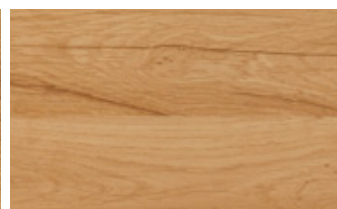

521 antique oak
521 antike-eiche
521 chêne antique
521 roble antiguo
521 dąb antyk



524 light pearwood
524 birnbaum hell
524 poirier clair
524 peral claro
524 grusza jasna

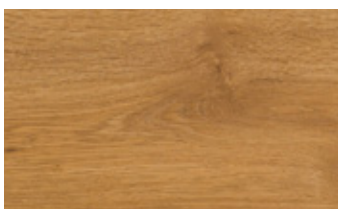

529 cordoba oak
529 eiche cordoba
529 chêne cordoba
529 roble córdoba
529 dąb cordoba

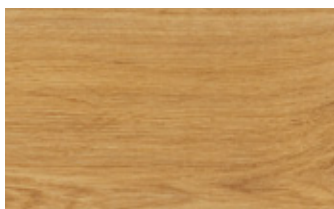

530 arizona oak
530 arizona-eiche
530 chêne arizona
530 roble arizona
530 dąb arizona

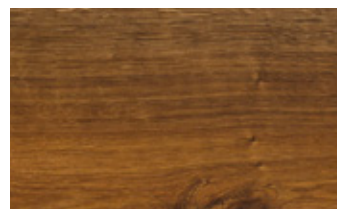

533 smoked oak
533 gebrannte eiche
533 chêne fumé
533 roble quemado
533 dąb palony

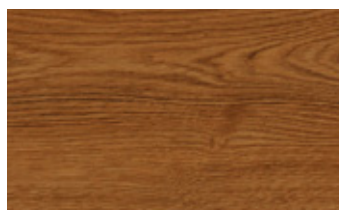

543 magnate oak
543 magnaten-eiche
543 chêne magnat
543 roble magnate
543 dąb magnacki

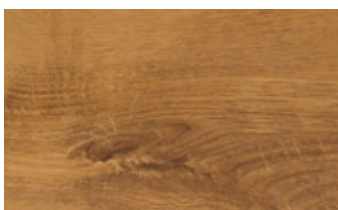

544 dartford oak
544 dartford-eiche
544 chêne dartford
544 roble dartford
544 dąb dartford

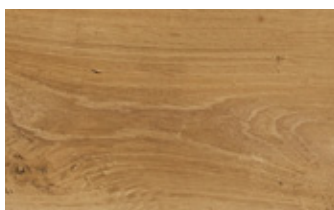

582 citrin oak
582 citrin-eiche
582 chêne citrin
582 roble citrin
582 dąb citrin



584 lemon oak
584 zitroneneiche
584 chêne citron
584 roble limón
584 dąb cytrynowy



585 californian oak
585 kalifornische eiche
585 chêne californien
585 roble californiano
585 dąb kalifornijski



5101 siberian oak
5101 sibirische eiche
5101 chêne de sibérie
5101 roble siberiano
5101 dąb syberyjski

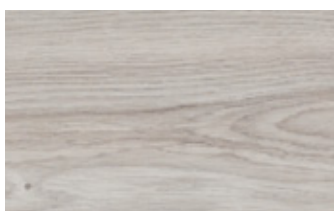

5102 norway spruce
5102 norwegische fichte
5102 épicea de norvège
5102 abeto noruego
5102 świerk norweski



5103 spanish oak
5103 spanische eiche
5103 chêne espagnol
5103 roble español
5103 dąb hiszpański

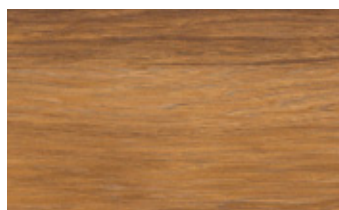

5104 andalusian oak
5104 andalusische eiche
5104 chêne andalouse
5104 roble andaluz
5104 dąb andaluzijski

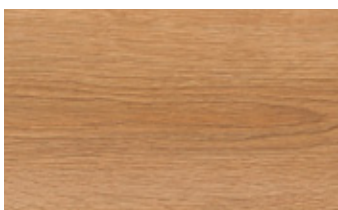

5105 oiled oak
5105 geölte eiche
5105 chêne huilé
5105 roble aceitado
5105 dąb olejowany

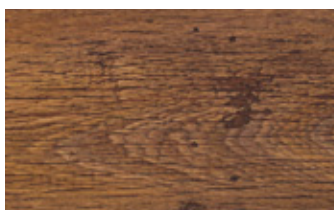

5106 castle oak
5106 schlosseiche
5106 chêne de château
5106 roble castillo
5106 dąb zamkowy

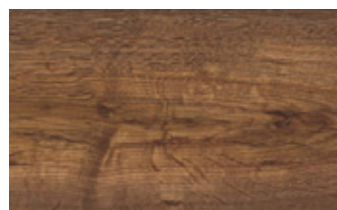

5107 terra oak
5107 terra-eiche
5107 chêne terre
5107 roble terra
5107 dąb terra

Advantages • Vorteile • Avantages • Ventajas • Zalety



EN | Quick installation. DE | Schnelle Montage. FR | La rapidité de la pose.
ES | Rápido montaje. PL | Szybkość montażu.

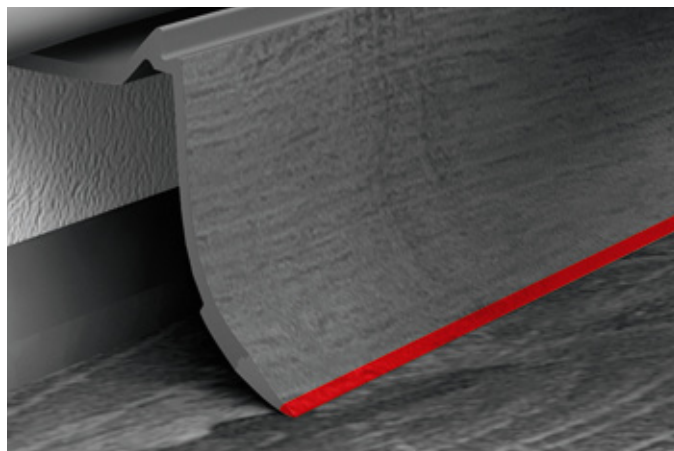

EN | Tightness. DE | Dichtheit. FR | L'étanchéité. ES | Ajustado.
PL | Szczelność.

Finishing • Abschlusselemente • Finitions • Acabado • Wykończenia



outer corner • Außenecke
• angle sortant • cantonera
exterior • narożnik zewnętrzny



inner corner • Innenecke
• angle rentrant • cantonera
interior • narożnik wewnętrzny



connector • Bindeglied
• barre de seuil • conector
• łącznik



side end plug • Blende
• cache • tapón extremo
lateral • zaślepka



quick fastener • Schnellverschluss
• clip de pose rapide
• cerradura rápida • kolek
szybkiego montażu



Dimensions • Abmessungen • Dimensions
• Dimensiones • Wymiary

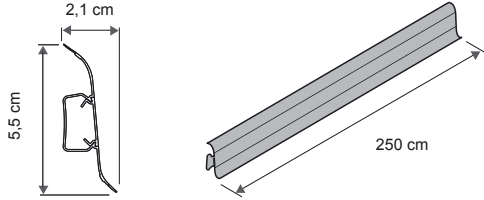

Logistic details • Logistikdaten • Données
Logistiques • Detalles logísticos • Dane logistyczne

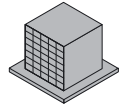
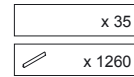
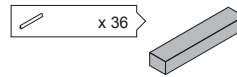

Assembly instruction • Montageanleitung • Notice de pose • Instrucciones de montaje • Instrukcja montażu

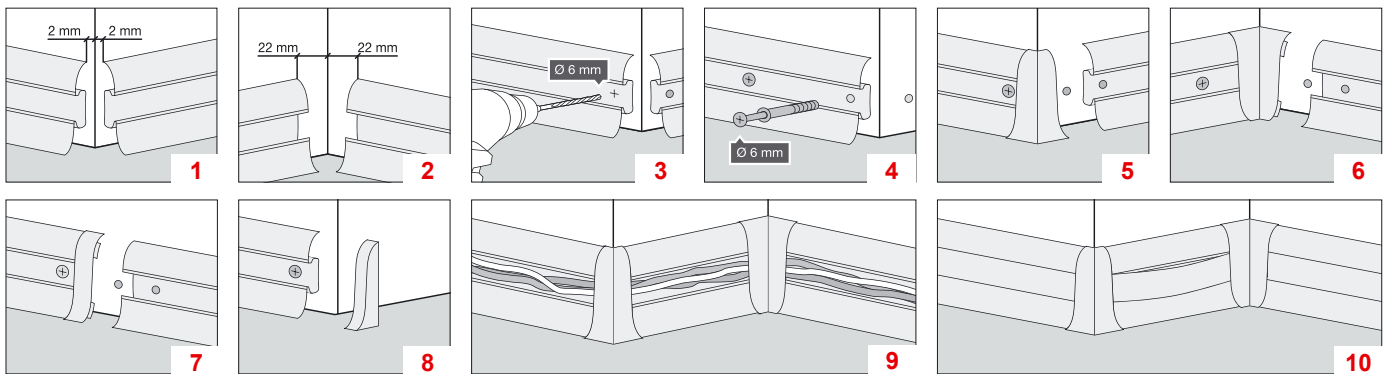

Approvals / Certificates / Guarantees • Zeugnisse / Zertifikate / Garantien • Attestations / Certifications /
Garanties • Ensayos / Certificados / Garantías • Atesty / Certyfikaty / Gwarancje

